



L-Series Family Generation 4

A comprehensive
commercial LED
lighting solution



L-Series Family of Architectural Recessed Lighting - Generation 4

Indy™ L-Series Luminaires are blazing new trails in commercial recessed lighting. The L-Series is a comprehensive collection of highly advanced LED luminaires covering the entire lighting spectrum. Downlighting, wall washing, adjustable accents, cylinders ... there is an exemplary solution for every application.

In an industry first, the L-Series offers you a fully coordinated family of luminaires, no matter your needs or requirements. From LED color rendering to aperture sizes and trim finishes, each luminaire is completely consistent across all fixture types and styles. Now you can achieve a totally homogeneous look and uniform LED performance regardless of application.

The fourth generation features improved efficacies by up to 20%, hyperbolic wall wash and narrow flood reflectors with 15 to 30 degree beam spreads, 90 and 97 CRI options, a broad range of lumen packages suitable for ceiling heights ranging from eight feet to more than 100 feet and a wide range of control options.

The comprehensive family of L-Series LED luminaires includes 4-, 6-, and 8-inch aperture sizes, offering brilliant illumination packages from 800, all the way up to 9,000 lumens. Glare-free Patented Hyperbolic downlights; single, double, or corner wall washers; and open-ceiling cylinder fixtures are just a few of the entries in this exquisite collection. Indy L-Series LED luminaires are truly the single source for all your commercial recessed lighting needs.



Indy L-Series LED Commercial Downlights
are built in Fishers, IN
BAA/ARRA Compliant



Downlight

- Patented Hyperbolic Reflector
- Parabolic Reflector
- Wide Flood, Flood and Narrow Flood distributions
- 800 to 9000 Lumens
- Flangeless
- Low-Profile



New Construction

Remodel

Retrofit

Indy L-Series LED downlights are available with patented hyperbolic reflectors that create the coveted "silent ceiling" look. Or traditionalists can go with the parabolic "quiet ceiling" look.

Wall Wash

- Hyperbolic Wall Wash
- Parabolic Wall Wash
 - Single
 - Double
 - Corner
- 800 to 9000 Lumens
- Flangeless
- Low Profile

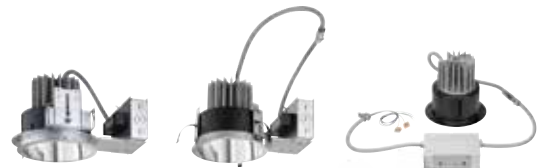

New Construction

Remodel

Retrofit

L-Series LED wall wash fixtures are available for single double or corner wall wash applications and feature patent pending lens technology for exceptionally uniform light distribution.

Adjustable Accent

- Spot (15°)
- Narrow Flood (22°)
- Flood (38°)
- 370° Rotation
- 45° Tilt
- 800 to 3300 Lumens



L-Series LED adjustables offer extraordinary aiming flexibility and interchangeable optics for accent lighting.

Cylinder







- Surface Mount
- Cable Mount
- Pendant
- Wall Mount
- Patented Hyperbolic Reflector
- Parabolic Reflector
- Wall Wash
- 800 to 5500 Lumens
- Black, White and Silver



L-Series LED cylinder fixtures offer hyperbolic or parabolic reflectors that match L-Series recessed downlights and are available in four mounting styles and three sizes.

L-Series, a comprehensive family of LED luminaires

Easy to Learn, Easy to Specify ...

Rough-in	Aperture Size			Reflector					Lumen Packages*																						
	4"	6"	8"	Hyperbolic Downlight	Parabolic Downlight	Hyperbolic Wall Wash	Single Wall Wash	Double Wall Wash	Corner Wall Wash	Angle Cut Cone	800	1300	1500	1700	2300	2800	3300	4000	4500	5000	5500	6000	6500	7000	7500	8000	8500	9000			
New Construction 	●	●	●	●	●	●	●	●	●		●	●	●	●	●	●	●	●	●	●	●	●	●	●	●	●	●	●	●	●	
Low-Profile, New Construction 	●			●	●	●	●	●	●		●	●	●	●	●	●	●	●	●												
Remodel 	●	●	●	●	●	●	●	●	●		●	●	●	●	●	●	●	●	●	●	●	●	●	●	●	●	●	●	●	●	●
Low-Profile, Remodel 	●			●	●	●	●	●	●		●	●	●	●	●	●	●	●	●												
Retrofit ▲ 		●	●	●	●	●	●	●	●		●	●	●	●	●	●	●	●	●	●	●	●	●	●	●	●	●	●	●	●	●
Cylinder 	●	●	●	●	●	●	●	●	●		●	●	●	●	●	●	●	●	●	●	●										
Adjustable 	●	●	●							●	●	●	●	●	●	●	●														

* 4" lumen packages do not exceed 8000lm at this time.

- ◆ Also available in Flangeless for New Construction
- ▲ Retrofit Downlights are also available in 9", 10" and 12"



L-Series, designed to be easy ...

Advances in LED light engines, drivers and heat sinks occur roughly every six months, and new products are constantly being introduced with varying performance, making it difficult for engineers, architects and lighting designers to keep up with new technology so they can specify the best products for their applications. The Indy L-Series has been designed to make it easy by offering a complete family of luminaires with fully coordinated performance and aesthetics across the entire line.

Easy to learn ...

Sharing many common components leads to common performance across the family ... and the performance is outstanding.

Common:

- Lumen Packages
- Trims and Trim Options
- Color Temperatures
- Beam Spreads
- Aperture Sizes

Easy to specify ...

To ease the specification process and ensure consistency among luminaires, the nomenclature for the L-Series family of products is consistent throughout, reducing the chance for mistakes.

- L = New Construction
- LRM = Remodel
- LRT = Retrofit
- LA = Adjustable Accent
- LC = Cylinder
- LLP = Low Profile New Construction
- LLPRM = Low Profile Remodel

Easy to choose ...

With industry leading performance, and a breadth of offering to suite any application, it's easy to make the Indy L-Series Family the go-to solution for all of your commercial lighting needs.

- CRI > 80 standard, 90 CRI and 97 CRI options available
- 18 lumen packages from 800-9000lm to accommodate any ceiling height
- Industry leading efficacies up to 130lm/W
- Downlight beam spreads ranging from 15° to 73° to accommodate any application
- ENERGY STAR® certified across the family
- Adjustable luminaires with beam spreads of 15°, 22° or 38°; and CBCP up to 18,000
 - Interchangeable spot, narrow flood and flood optics with excellent beam patterns
- Unique wall wash optics to maximize uniformity

Easy to upgrade

The Indy L-Series has always incorporated a modular "**future-proof**" design. Simply take the latest generation LED system and upgrade the previous generation rough-in.

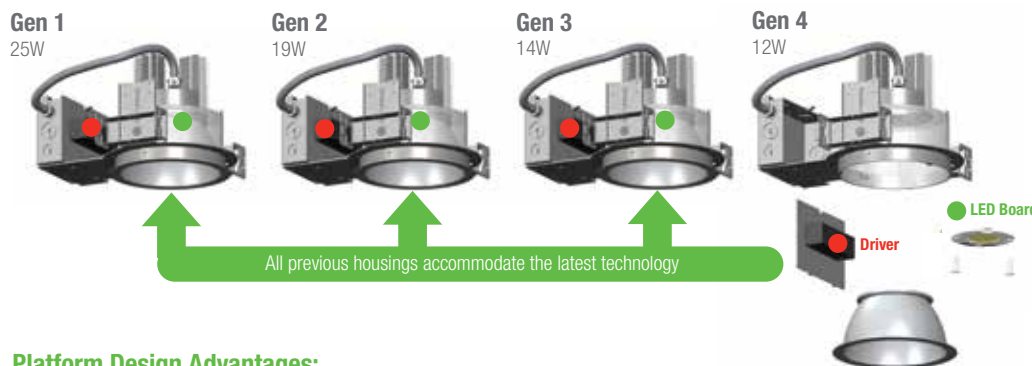

Gen 4 distribution and intensity same as previous generation fixtures, but much more efficient

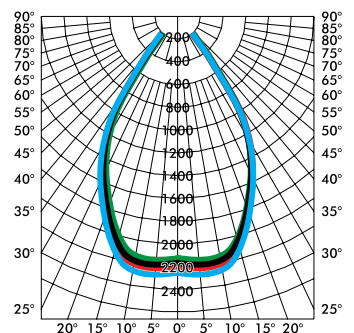

- Gen 1 ■
- Gen 2 ■
- Gen 3 ■
- Gen 4 ■

Platform Design Advantages:

- No need to change lighting layout. Light output, distribution and color remain the same
- Alleviate concerns about adopting new technology
- Peace of mind, no worry specifying Gen 3 and installing Gen 4
- Backward compatible, Gen 4 LED and driver fit into Gen 3, Gen 2 and Gen 1
- Easy to maintain from below

Where advanced LED technology meets innovation

Very Broad
Lumen Range

Up to 9000
Lumens

Choose from 18 lumen packages ranging from 800 to 9000lms.

Unique Aesthetics



Hyperbolic reflector and hyperbolic wall washer are exclusive to the L-Series family, and are available with downlights, retrofits and cylinders. Also available in Flangeless.

100 ft. Ceilings
and Beyond

100ft

L-Series family provides illumination from 8- to-100-foot ceiling heights.

Universal Retrofit



A true universal retrofit that converts nearly any existing 6", 8", 9", 10" or 12" fixture to LED.

Chip-On-Board (COB) Technology



LEDs are under driven and covered with a single homogenous phosphor layer, providing high efficacies and superior fixture-to-fixture color consistency.

Excellent Efficacy
and Payback



Up to
130 lm/W
with over 80% savings

COB technology and Patented Hyperbolic reflectors deliver efficacies up to 130 lm/W. ENERGY STAR® Certified across the family. Annual operating savings of over 80% vs CFL.

Effortless IoT



Atrius™-Ready products, part of the Atrius Sensory Network, are ready to deliver valuable data and connectivity to the Atrius Software Services (see p.11).

Shallow Plenum
Solutions



Low-profile fixtures are available with heights as low as 2-inches for ceilings with shallow plenum or obstructions.

Multiple Control/
Dimming Options

Dimming Range
Down to <1%

Select from : 0-10V, Forward/Reverse Phase,
Lutron® Forward Phase, Lutron® EcoSystem®,
DMX, DALI, nLight®, and eldoLED®

Future Proof &
Backward Compatible

Platform Design
Ensures Easy
Specifications

Can specify Gen 3 & install Gen 4. Or take
the latest LED technology & upgrade previous
generation, while preserving the same
distribution & intensity.

Easy Maintenance
from Below



Specially designed to minimize time and
effort to replace the LED light engine
and/or driver.



Introducing the Silent Ceiling™

For use with L-Series Downlights, Retrofits and Cylinders

Hyperbolic



Indy L-Series patented Hyperbolic reflectors are available in a variety of colors and finishes.



All reflectors are available in Specular, Semi-Specular and Satin finishes. Retrofit reflectors, LRT6, LRT8, LRT9, LRT10 and LRT12 are only available in Clear and White colors.

Silent Ceiling Includes:

- Patented Hyperbolic Reflectors (US Patent 10,670,227 B2) with 15° - 75° Beam Spreads
- Hyperbolic Wall Wash (Single Wall Washer)
- Glare eliminating, 45-degree visual cutoff

Flangeless Reflectors

The sophisticated look of flangeless can now be achieved with Indy L-Series Flangeless Reflectors. They have been painstakingly designed to eliminate cracking problems that can ruin the tranquil look of an uninterrupted ceiling.

Drywall Flangeless Installation



Over 20% more efficacy and lumen output

Advanced Silent Ceiling™ Hyperbolic



The innovative Indy L-Series LED Luminaires have taken the “quiet” ceiling effect to a whole new level. The patented Hyperbolic reflector design is so effective at reducing glare that, instead of “quiet,” we now refer to ceilings as “silent.” The patented Hyperbolic shape provides over 20% more lumens by directing all light at the target work plane. Increased lumens accommodate increased ceiling height and better control of the light allows multiple beam spreads.

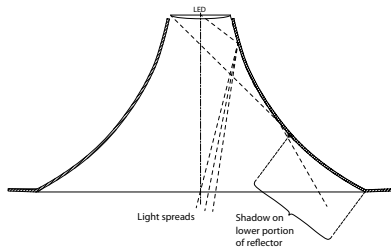

Traditional Quiet Ceiling Parabolic



In addition to hyperbolic reflectors, Indy L-Series LED Luminaires are also available with parabolic reflectors. They feature a regressed lens that optimizes light distribution and shields the light source from view when off. They produce high-quality, brilliant white light that is ideal for commercial applications where a traditional look is desired. Parabolic reflectors are available with all the same trim finish options in the hyperbolic reflector line.

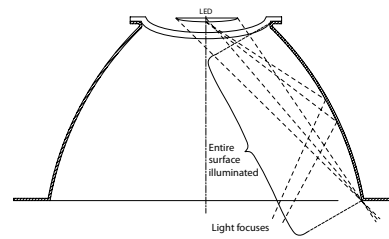

Indy™ Low-Profile Recessed LED Luminaires

L-Series quality and performance, even in the tightest spaces

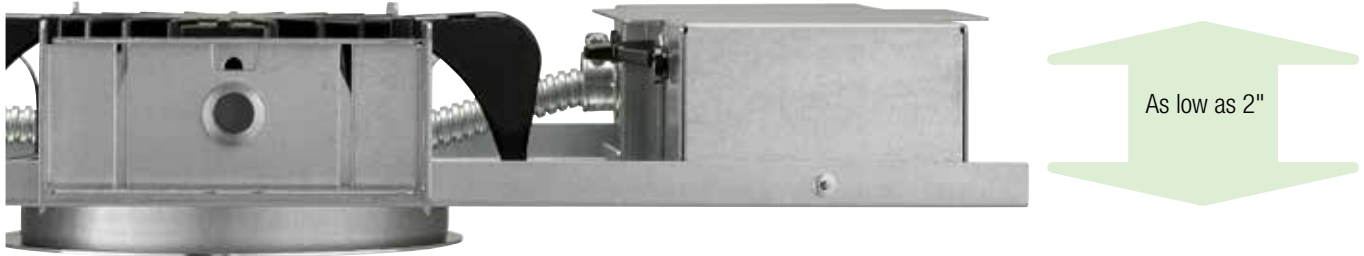

Quality lighting is now attainable in very tight spaces. With Indy L-Series Low-Profile LED Luminaires, installation can occur with as little as 2-inches of plenum space! Better yet, these low-profile luminaires offer the same great features as traditional L-Series fixtures with no compromise in performance or quality.

The Indy L-Series Low-Profile delivers unmatched performance and visual comfort including:

- Up to 3000 lumens with a 2" high fixture
- Up to 4800 lumens with a 3" high fixture
- 128 lumens per watt
- 45° visual cutoff

The secret to this unmatched performance is the patented Indy Hyperbolic reflector

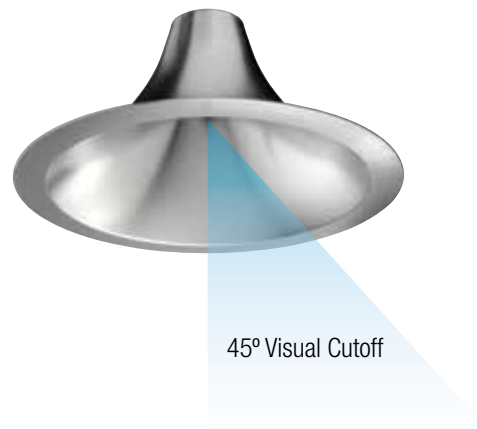

New Construction



Remodel

Indy L-Series Low-Profile LED luminaires are available in new construction and remodel versions. Each provides an ideal low-profile solution – without compromising on quality or performance.

Indy™ Innovation: The Low-Profile Advantage

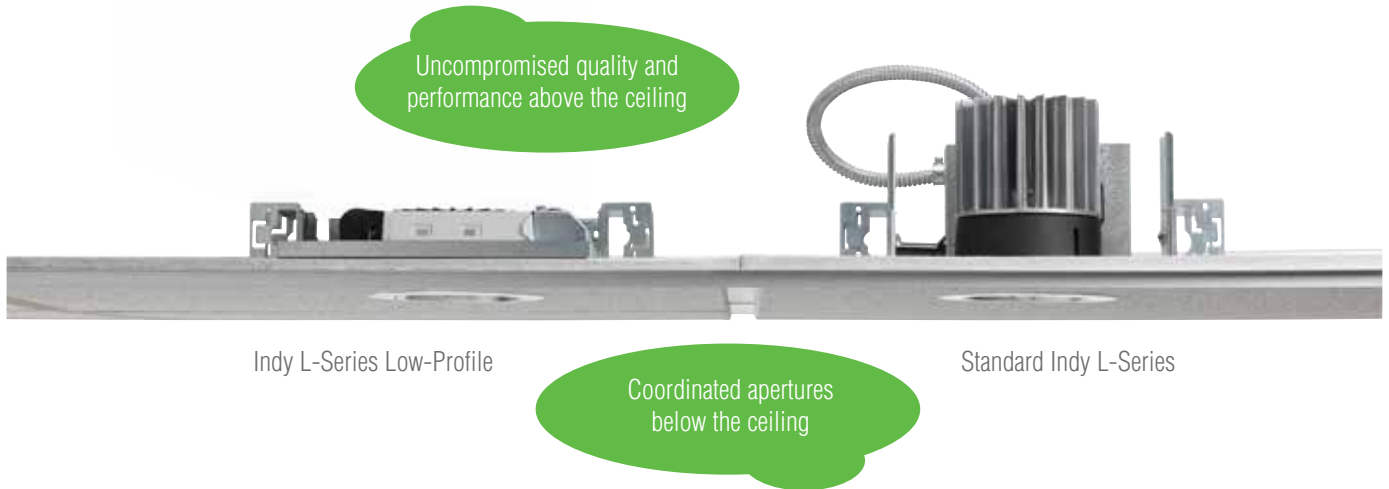

Low-plenum construction trends have driven the need for lower-profile lighting fixtures. The Indy L-Series continues to deliver ground breaking solutions to meet today's constantly changing needs.

Future-Proof Design

Indy L-Series fixtures (including low-profile luminaires) are easy to maintain and upgrade. All maintenance can be done from below the ceiling, particularly when upgrading the driver and LED to a future generation.



Multiple reflector options and finishes are available, that match the standard L-Series family.

Field-Replaceable Reflectors



Designer Finishes





L-Series Gen 4

Now Atrius™-Ready



Atrius IoT Solutions – Create Brilliant Experiences

Over the next few years, millions of lights will be converted to LED technology. And with the average lifespan of more than 10 years, your choice of luminaires carries a long-lasting impact. Atrius-Ready luminaires and devices from Acuity Brands lay the track for a powerful, connected infrastructure, making it the ideal platform to enable the "internet of things." Atrius IoT solutions enable digital experiences in your space by effortlessly unlocking rich services for developers, businesses and customers.



Right Location

Everywhere there are people, there are lights, indoor and outdoor, creating a consistent grid placement and a dense sensory network.



Right Connection

Atrius-Ready luminaires provide the ubiquity for constant power and continuous connectivity to people in your space.



Right Time

Atrius-Ready luminaires deliver scalable, future-proof value for your business now and in the future.

L-Series Gen 4 is part of the Atrius Sensory Network

Choosing products enabled with Atrius today allows you to connect systems, technology and people throughout the lifecycle of your facility and unlock value-added building and business applications.

Featuring embedded Bluetooth® Low Energy technology beacons, the L-Series Gen 4 lays the foundation for a scalable infrastructure, allowing you to leverage your building's sensory network to enable IoT platform services such as indoor positioning and wayfinding.

Indoor Positioning Services with Atrius Navigator

Highly accurate wayfinding and location-based services, providing more engaging, enjoyable and efficient journeys for your customers.

For more information about Atrius IoT Solutions,
visit www.acuitybrands.com/atrius

L-Series Generation 4 with nLight®

L-Series fixtures can be nLight enabled for connection to nLight digital networks. This provides digital lighting controls that increase energy savings and user configurability through the cost-effective integration of time-based, daylight-based, sensor-based and manual lighting control schemes.

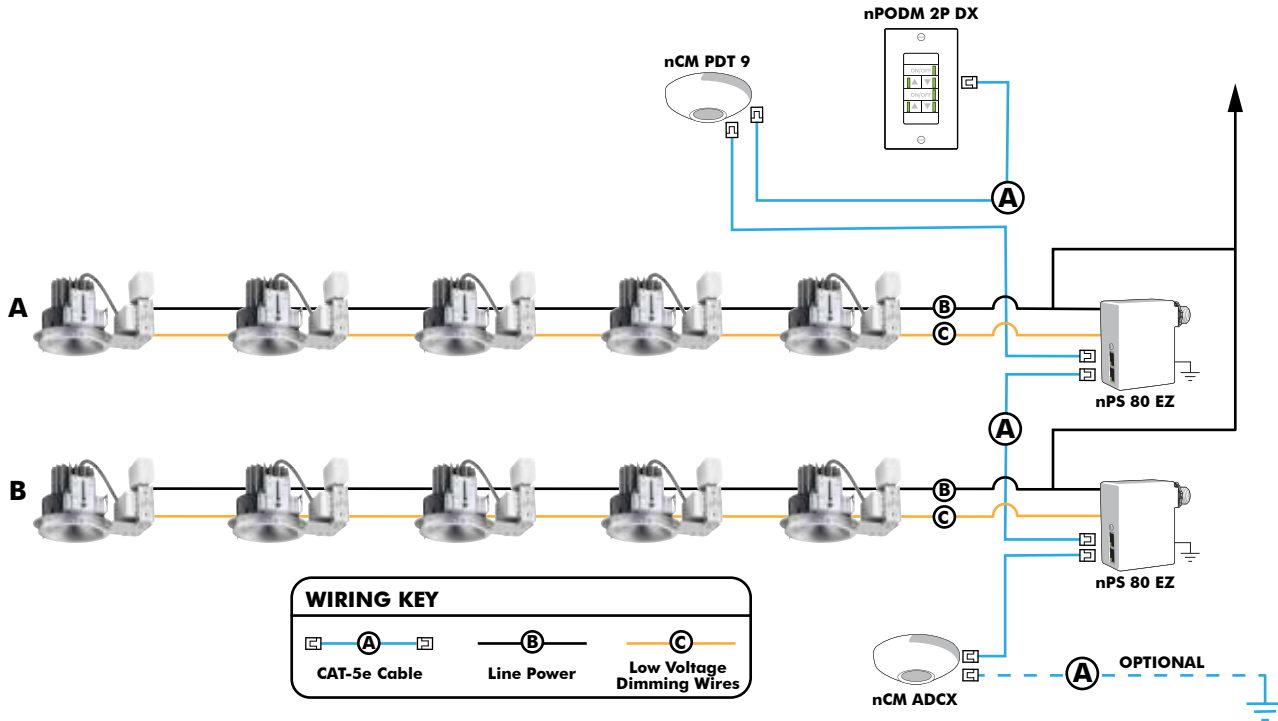

nLight enabled fixtures are available across the entire Indy L-Series family



L-Series Generation 4 with nLight® AIR

L-Series fixtures can be nLight Air enabled. This is the ideal solution for retrofit or new construction spaces where adding wired communication is cost prohibitive. The integrated nLight AIR rPP20 Power Pack delivers wireless individually addressable controls for the ultimate in flexibility during initial setup and for space repurposing.



Simple as 1, 2, 3

1. Install the nLight® AIR fixtures
2. Install the wireless battery-powered wall switch
3. With CLAIRITY™ app, pair the fixtures with the wall switch



nLight AIR rPODB 2P DX

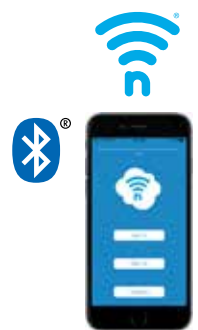

Mobile Device

nLight AIR enabled fixtures are available across the entire Indy L-Series family



 The Bluetooth® word mark and logos are registered trademarks owned by Bluetooth SIG, Inc. and any use of such marks by Acuity Brands Lighting, Inc. is under license. Other trademarks and trade names are those of their respective owners.

L-Series Family - Generation 4

Coordinated apertures for all applications

Easy to Choose ...



Photo Credits:
Cover and Page 9: Acuity Brands Office, Des Plaines, IL (PictureBoy)
Page 7: Wintrust Financial, Rosemont, Illinois (Hugh Lighting Design)

